

Approval body for construction products
and types of construction

Bautechnisches Prüfamt

An institution established by the Federal and
Laender Governments



European Technical Assessment

ETA-02/0020
of 1 June 2021

English translation prepared by DIBt - Original version in German language

General Part

Technical Assessment Body issuing the
European Technical Assessment:

Deutsches Institut für Bautechnik

Trade name of the construction product

Drop-in Anchor E / ES

Product family
to which the construction product belongs

Mechanical fastener for use in concrete

Manufacturer

MKT
Metall-Kunststoff-Technik GmbH & Co. KG
Auf dem Immel 2
67685 Weilerbach

Manufacturing plant

MKT
Metall-Kunststoff-Technik GmbH & Co. KG
Auf dem Immel 2
67685 Weilerbach

This European Technical Assessment
contains

16 pages including 3 annexes which form an integral part
of this assessment

This European Technical Assessment is
issued in accordance with Regulation (EU)
No 305/2011, on the basis of

EAD 330232-01-0601 Edition 05/2021

This version replaces

ETA-02/0020 issued on 1 March 2016

The European Technical Assessment is issued by the Technical Assessment Body in its official language. Translations of this European Technical Assessment in other languages shall fully correspond to the original issued document and shall be identified as such.

Communication of this European Technical Assessment, including transmission by electronic means, shall be in full. However, partial reproduction may only be made with the written consent of the issuing Technical Assessment Body. Any partial reproduction shall be identified as such.

This European Technical Assessment may be withdrawn by the issuing Technical Assessment Body, in particular pursuant to information by the Commission in accordance with Article 25(3) of Regulation (EU) No 305/2011.

Specific Part

1 Technical description of the product

The Drop-in Anchor E / ES is a fastener made of galvanized steel, stainless steel or high corrosion resistant steel which is placed into a drilled hole and anchored by deformation-controlled expansion.

The product description is given in Annex A.

2 Specification of the intended use in accordance with the applicable European Assessment Document

The performances given in Section 3 are only valid if the anchor is used in compliance with the specifications and conditions given in Annex B.

The verifications and assessment methods on which this European Technical Assessment is based lead to the assumption of a working life of the anchor of at least 50 years. The indications given on the working life cannot be interpreted as a guarantee given by the producer, but are to be regarded only as a means for choosing the right products in relation to the expected economically reasonable working life of the works.

3 Performance of the product and references to the methods used for its assessment

3.1 Mechanical resistance and stability (BWR 1)

Essential characteristic	Performance
Characteristic resistance to tension load (static and quasi-static loading) Method A	See Annex B2, C1 to C2
Characteristic resistance to shear load (static and quasi-static loading)	See Annex C3 to C4
Displacements	See Annex C5
Characteristic resistance and displacements for seismic performance category C1 and C2	No performance assessed

3.2 Safety in case of fire (BWR 2)

Essential characteristic	Performance
Reaction to fire	Class A1
Resistance to fire	No performance assessed

3.3 Aspects of durability linked with the Basic Works Requirements

Essential characteristic	Performance
Durability	See Annex B1

English translation prepared by DIBt

4 Assessment and verification of constancy of performance (AVCP) system applied, with reference to its legal base

In accordance with the European Assessment Document EAD 330232-01-0601 the applicable European legal act is: [96/582/EC].

The system to be applied is: 1

5 Technical details necessary for the implementation of the AVCP system, as provided for in the applicable EAD





















Technical details necessary for the implementation of the AVCP system are laid down in the control plan deposited with Deutsches Institut für Bautechnik.

Issued in Berlin on 1 June 2021 by Deutsches Institut für Bautechnik

Dipl.-Ing. Beatrix Wittstock
Head of Section

beglaubigt:
Lange

Drop-in Anchor E / ES

Anchor sizes and variations					
Drop-in Anchor E (<u>without</u> shoulder)			Drop-in Anchor ES (<u>with</u> shoulder)		
E M6x30			ES M6x30		
E M8x30			ES M8x30		
E M8x40			ES M8x40		
E M10x40	 		ES M10x30 (zinc plated)		
E M12x50			ES M10x40	 	
E M12x80			ES M12x50		
E M16x65			ES M12x80		
E M16x80			ES M16x65	 	
E M20x80	ES M16x80				

Installation situation

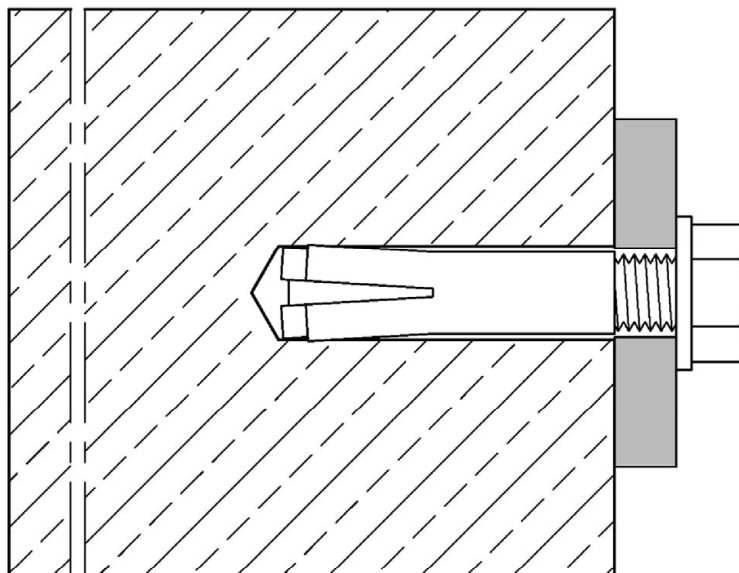

Drop-in Anchor E / ES

Product description
Anchor sizes and variations / Installation situation

Annex A1

Table A1: Material

Part	Designation	Steel, zinc plated	Stainless steel A4	High corrosion resistant steel HCR
1	Anchor sleeve	Cold formed or machining steel, galvanized, EN ISO 4042:2018	Stainless steel (e.g. 1.4401, 1.4404, 1.4571) EN 10088:2014, EN ISO 3506:2020	Stainless steel, 1.4529, 1.4565, EN 10088:2014, EN ISO 3506:2020
2	Cone	Cold formed or machining steel	Stainless steel (e.g. 1.4401, 1.4404, 1.4571) EN 10088:2014	

Requirements on the fastening screw or the threaded rod and nut according to the engineering documents:

- Minimum screw-in depth L_{smin} see Table B1
- The length of screw or the threaded rod shall be determined depending on the thickness of fixture t_{fix} , available thread length L_{th} (= maximum screw-in depth) and the minimum screw-in depth L_{smin} .
- $A_5 > 8$ % Ductility
- Materials
 - **Steel, zinc plated**, property class 4.6 / 4.8 / 5.6 / 5.8 or 8.8 according to EN ISO 898-1:2013 or EN ISO 898-2:2012
 - **Stainless steel A4** or **high corrosion resistant steel HCR**, property class 70 or 80 according to EN ISO 3506:2020

Drop-in Anchor E / ES

Product description
Materials / Requirements

Annex A2

Anchor sleeve

Anchor version without shoulder (E)

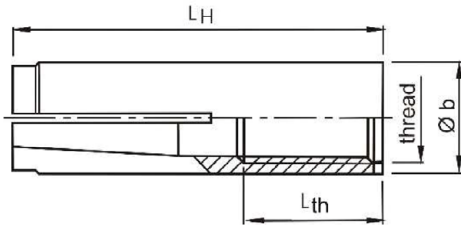

Anchor version with shoulder (ES)

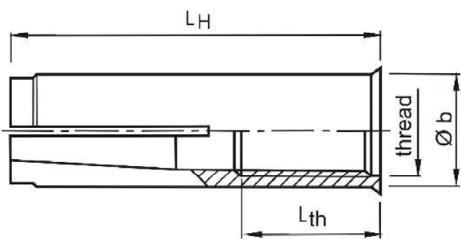

Marking: see Table A2

e.g.:  E M8x40

-  identifying mark of manufacturing plant
- E anchor identity (version without shoulder)
- ES anchor identity (version with shoulder)
- M8 size of thread
- 40 anchorage depth

additional marking

- A4 stainless steel
- HCR high corrosion resistant steel

Cone



































M6x30 and M10x30



remaining sizes

Table A2: Dimensions and marking

Anchor size	Anchor sleeve				Marking			Cone
	thread	Ø b	L _H	L _{th}	Version E (without sleeve)	Version ES (with sleeve)	alternative	
M6x30	M6	8	30	13	 E M6x30	 ES M6x30	 E M6	
M8x30	M8	10	30	13	 E M8x30	 ES M8x30	 E M8	
M8x40	M8	10	40	20	 E M8x40	 ES M8x40	 E M8x40	
M10x30	M10	12	30	12	-	 ES M10x30	 E M10x30	
M10x40	M10	12	40	15	 E M10x40	 ES M10x40	 E M10	
M12x50	M12	15	50	18	 E M12x50	 ES M12x50	 E M12	
M12x80	M12	15	80	45	 E M12x80	 ES M12x80	 E M12x80	
M16x65	M16	19,7	65	23	 E M16x65	 ES M16x65	 E M16	
M16x80	M16	19,7	80	38	 E M16x80	 ES M16x80	 E M16x80	
M20x80	M20	24,7	80	34	 E M20x80	-	 E M20	

Dimensions in mm

Drop-in Anchor E / ES

Product description
Dimensions and marking

Annex A3

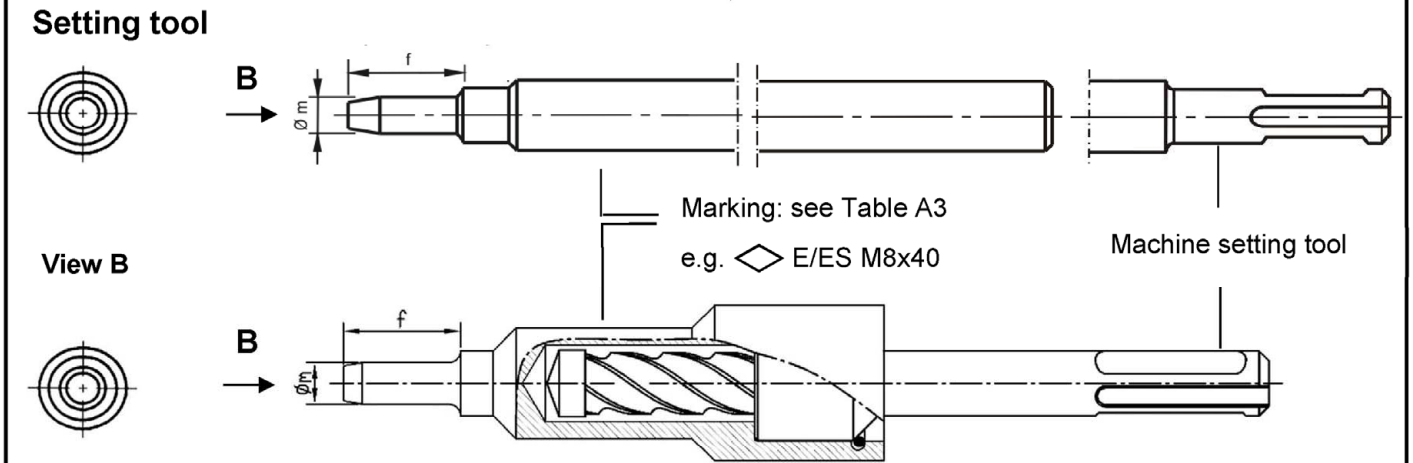
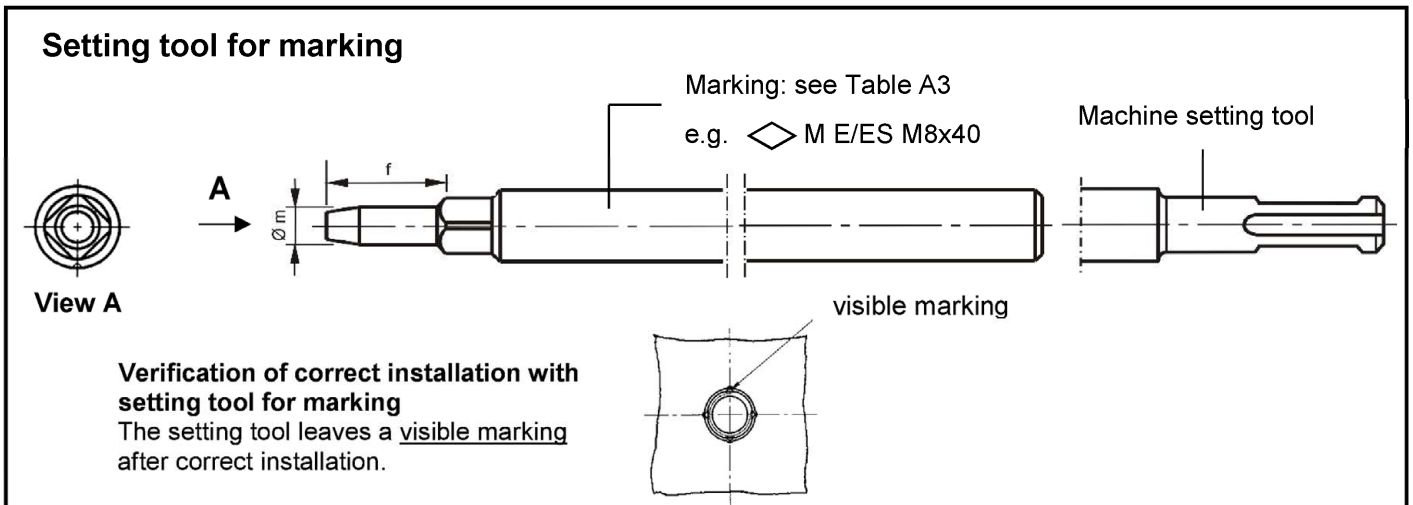

Table A3: Dimensions and marking of setting tools

Anchor size	$\varnothing m$	f	Setting tool for marking		Setting tool	
			Marking	alternative	Marking	alternative
M6x30	4,9	17	$\diamond M E/ES M6x30$	$\diamond M E M6$	$\diamond E/ES M6x30$	$\diamond E M6$
M8x30	6,4	18	$\diamond M E/ES M8x30$	$\diamond M E M8$	$\diamond E/ES M8x30$	$\diamond E M8$
M8x40	6,4	28	$\diamond M E/ES M8x40$	$\diamond M E M8x40$	$\diamond E/ES M8x40$	$\diamond E M8x40$
M10x30	8,0	18	$\diamond M ES M10x30$	$\diamond M E M10x30$	$\diamond ES M10x30$	$\diamond E M10x30$
M10x40	8,0	24	$\diamond M E/ES M10x40$	$\diamond M E M10$	$\diamond E/ES M10x40$	$\diamond E M10$
M12x50	10,0	30	$\diamond M E/ES M12x50$	$\diamond M E M12$	$\diamond E/ES M12x50$	$\diamond E M12$
M12x80	10,0	60	$\diamond M E/ES M12x80$	$\diamond M E M12x80$	$\diamond E/ES M12x80$	$\diamond E M12x80$
M16x65	13,5	36	$\diamond M E/ES M16x65$	$\diamond M E M16$	$\diamond E/ES M16x65$	$\diamond E M16$
M16x80	13,5	51	$\diamond M E/ES M16x80$	$\diamond M E M16x80$	$\diamond E/ES M16x80$	$\diamond E M16x80$
M20x80	16,5	50	$\diamond M E M20x80$	$\diamond M E M20$	$\diamond E M20x80$	$\diamond E M20$

Dimensions in mm

Drop-in Anchor E / ES

Product description
Setting tools / Dimensions and marking

Annex A4

Specifications of intended use

Anchorage subject to:

- Static and quasi-static loads

Base materials:

- Compacted, reinforced or unreinforced normal weight concrete, without fibres according to EN 206:2013 + A1:2016
- Uncracked concrete
- Strength classes C20/25 to C50/60 according to EN 206:2013 + A1:2016

Use conditions (Environmental conditions):

- Structures subject to dry internal conditions (all materials)
- For all other conditions applies:
Use according to EN 1993-1-4:2015 corresponding to corrosion resistance class CRC according to Annex A2, Table A1:
 - Stainless steel A4: CRC III
 - High corrosion resistant steel HCR: CRC V
- Anchor types M6x30 A4 and M8x30 A4 only for dry internal exposure

Design:

- Anchorages are designed under the responsibility of an engineer experienced in anchorages and concrete work.
- Verifiable calculation notes and drawings are prepared taking account of the loads to be anchored. The position of the anchor is indicated on the design drawings (e.g. position of the anchor relative to reinforcement or to supports, etc.).
- The strength class and the length of the fastening screw or threaded rod shall be defined by the designing engineer
- Design of fastenings according EN 1992-4:2018 (and TR 055, if necessary)
- Anchor sizes M6x30, M8x30 and M10x30 for statically indeterminate structural components only, when in case of failure, the load can be distributed to other fasteners.

Installation:

- Anchor installation in accordance with the manufacturer's specifications and drawings and using the appropriate tools
- Drill hole by hammer drilling or vacuum drilling

Drop-in Anchor E / ES

Intended use
Specifications

Annex B1

Table B1: Installation parameters

Anchor size		M6x30	M8x30	M8x40	M10x30	M10x40	M12x50	M12x80	M16x65	M16x80	M20x80
Depth of drill hole	$h_0 =$ [mm]	30	30	40	30	40	50	80	65	80	80
Drill hole diameter	$d_0 =$ [mm]	8	10	10	12	12	15	15	20	20	25
Cutting diameter of drill bit	$d_{cut} \leq$ [mm]	8,45	10,45	10,45	12,5	12,5	15,5	15,5	20,55	20,55	25,55
Max. installation torque ¹⁾	$T_{inst} \leq$ [Nm]	4	8	8	15	15	35	35	60	60	120
Diameter of clearance hole in the fixture	$d_f \leq$ [mm]	7	9	9	12	12	14	14	18	18	22
Thread length	L_{th} [mm]	13	13	20	12	15	18	45	23	38	34
Minimum screw-in depth	L_{sdmin} [mm]	7	9	9	10	11	13	13	18	18	22
Steel, zinc plated											
Minimum thickness of member	h_{min} [mm]	100	100	100	120	120	130	130	160	160	200
Minimum spacing	s_{min} [mm]	55	60	80	100	100	120	120	150	150	160
Minimum edge distance	c_{min} [mm]	95	95	95	115	135	165	165	200	200	260
Stainless steel A4, HCR											
Minimum thickness of member	h_{min} [mm]	100	100	100	-	130	140	140	160	160	250
Minimum spacing	s_{min} [mm]	50	60	80	-	100	120	120	150	150	160
Minimum edge distance	c_{min} [mm]	80	95	95	-	135	165	165	200	200	260

¹⁾ If the screw or threaded rod is otherwise secured against unscrewing, the torque can be omitted

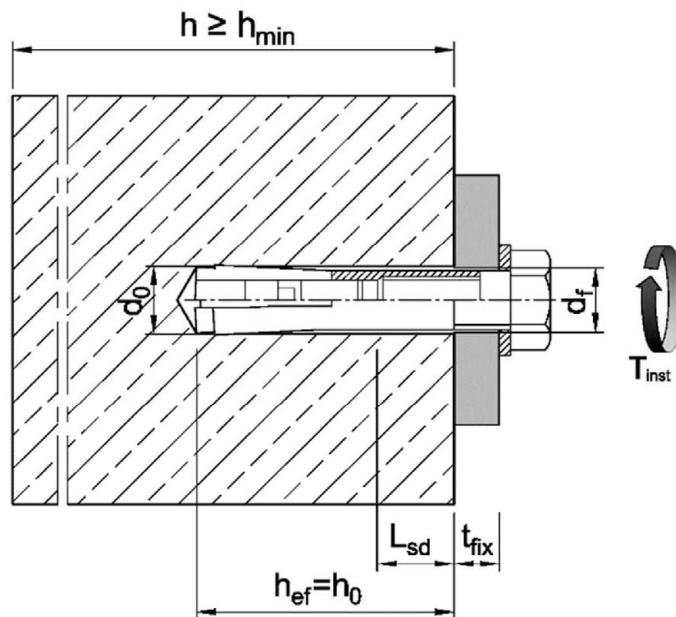

Drop-in Anchor E / ES

Intended use
Installation parameters

Annex B2

Installation instructions

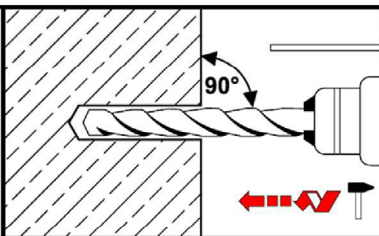
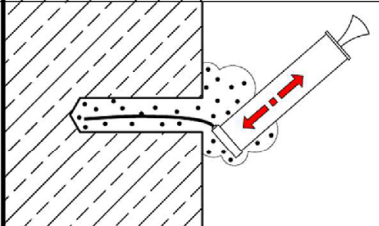
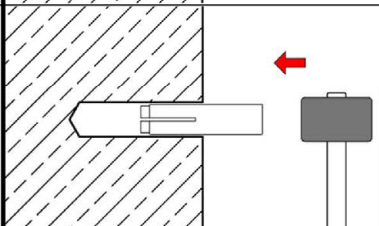
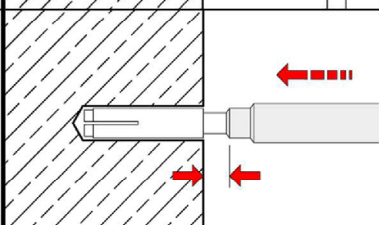
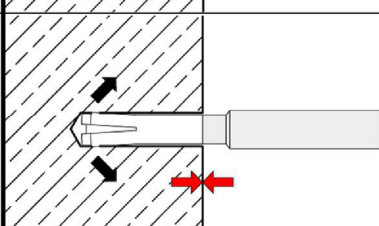
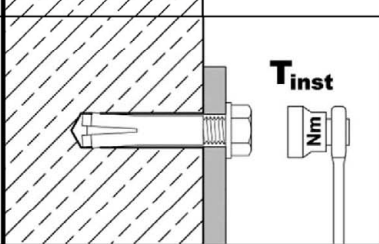
1		<p>Drill hole perpendicular to concrete surface. Using vacuum drill bit proceed with step 3.</p>
2		<p>Blow out dust. Alternatively, vacuum clean down to the bottom of the hole.</p>
3		<p>Drive in anchor.</p>
4		<p>Drive in cone by using setting tool.</p>
5		<p>Shoulder of setting tool must fit on anchor rim.</p>
6		<p>Turn in screw or threaded rod with nut, observe minimum screw-in depth (see Annex B2). Apply installation torque T_{inst}.</p>

Drop-in Anchor E / ES

Intended use
Installation instructions

Annex B3

Table C1: Characteristic values for tension loads, zinc plated steel

Anchor size			M6x30	M8x30	M8x40	M10x30	M10x40	M12x50	M12x80	M16x65 M16x80	M20x80		
Installation factor	γ_{inst}	[-]	1,2										
Steel failure													
Characteristic resistance	property class	$N_{Rk,s}$ [kN]	4.6	8,0	14,6	23,2		33,7		62,8	98,0		
			4.8	8,0	14,6	18,0	20,2	33,7		62,8	98,0		
			5.6	10,0	18,3		18,0	20,2	42,1		78,3	122,4	
			5.8	10,0	17,6	18,3	18,0	20,2	40,2	42,1	67,1	106,4	
			8.8	15,0	17,6	19,9	18,0	20,2	40,2	43,0	67,1	106,4	
Partial factor	property class	$\gamma_{Ms}^{1)}$ [-]	2,0										
			2,0			1,5		2,0					
			1,5						1,6				
Pull-out failure													
Characteristic resistance in concrete C20/25	$N_{Rk,p}$	[kN]	8,1	8,1	9,0	8,1	12,4	17,4	17,4	25,8	35,2		
Increasing factor	ψ/c	[-]	$\left(\frac{f_{ck}}{20}\right)^{0,5}$		$\left(\frac{f_{ck}}{20}\right)^{0,3}$	$\left(\frac{f_{ck}}{20}\right)^{0,5}$							
Splitting													
Characteristic resistance in concrete C20/25	$N^0_{Rk,sp}$	[kN]	min ($N_{Rk,p}$; $N^0_{Rk,c}$)										
Characteristic edge distance	$c_{cr,sp}$	[mm]	95	95	95	115	135	165	200	260			
Characteristic spacing	$s_{cr,sp}$	[mm]	$2 \cdot c_{cr,sp}$										
Concrete cone failure													
Effective anchorage depth	h_{ef}	[mm]	30	30	40	30	40	50	80	65 80 ²⁾	80		
Characteristic edge distance	$c_{cr,N}$	[mm]	$1,5 h_{ef}$										
Characteristic spacing	$s_{cr,N}$	[mm]	$2 \cdot c_{cr,N}$										
Factor	uncracked concrete	$k_{ucr,N}$	11,0										
	cracked concrete	$k_{cr,N}$	No performance assessed										

¹⁾ in absence of other national regulations

²⁾ for M16x80

Drop-in Anchor E / ES

Performance
Characteristic values for **tension loads, zinc plated steel**

Annex C1

Table C2: Characteristic values for tension loads, stainless steel A4, HCR

Anchor size			M6x30	M8x30	M8x40	M10x40	M12x50 M12x80	M16x65 M16x80	M20x80
Installation factor	γ_{inst}	[-]	1,0						
Steel failure									
Characteristic resistance (property class 70)	$N_{Rk,s}$	[kN]	14,1	23,3		29,4	50,2	83,8	133,0
Characteristic resistance (property class 80)	$N_{Rk,s}$	[kN]	17,5	23,3		29,4	50,2	83,8	133,0
Partial factor	$\gamma_{Ms}^{1)}$	[-]	1,87						
Pull-out failure									
Characteristic resistance in concrete C20/25	$N_{Rk,p}$	[kN]	8,1	8,1	11,0	12,4	17,4	25,8	35,2
Increasing factor	ψ_C	[-]	$\left(\frac{f_{ck}}{20}\right)^{0,5}$		$\left(\frac{f_{ck}}{20}\right)^{0,3}$	$\left(\frac{f_{ck}}{20}\right)^{0,5}$			
Splitting failure									
Characteristic resistance in concrete C20/25	$N^0_{Rk,sp}$	[kN]	min ($N_{Rk,p}$; $N^0_{Rk,c}$)						
Edge distance	$c_{cr,sp}$	[mm]	80	95	95	135	165	200	260
Spacing	$s_{cr,sp}$	[mm]	$2 \cdot c_{cr,sp}$						
Concrete cone failure									
Effective anchorage depth	h_{ef}	[mm]	30	30	40	40	50 80 ²⁾	65 80 ²⁾	80
Edge distance	$c_{cr,N}$	[mm]	$1,5 h_{ef}$						
Spacing	$s_{cr,N}$	[mm]	$2 \cdot c_{cr,N}$						
Factor	uncracked concrete	$k_{ucr,N}$	11,0						
	cracked concrete	$k_{cr,N}$	No performance assessed						

¹⁾ in absence of other national regulations

²⁾ for M12x80 and M16x80

Drop-in Anchor E / ES

Performance
Characteristic values for **tension loads, stainless steel A4, HCR**

Annex C2

Table C3: Characteristic values for shear loads, zinc plated steel

Anchor size				M6x30	M8x30	M8x40	M10x30	M10x40	M12x50	M12x80	M16x65 M16x80	M20x80	
Steel failure without lever arm													
Characteristic resistance	property class	4.6	$V^0_{Rk,s}$ [kN]	4,0	7,3	11,6	9,6	16,8		31,3	49,0		
		4.8		4,0	7,3	10,1	10,1	16,9		31,3	49,0		
		5.6		5,0	9,1	10,1	9,6	21,1		39,2	61,2		
		5.8		5,0	6,9	10,1	7,2	19,4	21,1	33,5	53,2		
		8.8		5,0	6,9	10,1	7,2	19,4	21,5	33,5	53,2		
Partial factor	property class	4.6	$\gamma_{Ms}^{1)}$ [-]	1,67									
		5.6		1,67			1,25	1,67					
		4.8		1,25									1,33
		5.8		1,25									1,33
		8.8		1,25									1,33
Duktilitätsfaktor			k_7 [-]	1,0									
Steel failure with lever arm													
Characteristic bending resistance	property class	4.6	$M^0_{Rk,s}$ [Nm]	6,1	15	30		52		133	259		
		4.8		7,6	19	37		65		166	324		
		5.6		12	30	59	60	105		266	519		
		8.8		1,67									
Partial factor	property class	4.6	$\gamma_{Ms}^{1)}$ [-]	1,67									
		5.6		1,67									
		4.8		1,25									
		5.8		1,25									
		8.8		1,25									
Factor of ductility			k_7 [-]	1,0									
Concrete pry-out failure													
Pry-out factor			k_8 [-]	1,0				1,5	2,0				
Concrete edge failure													
Effective length of fastener in shear loading			l_f [mm]	30	30	40	30	40	50	80	65 80 ²⁾	80	
Outside diameter of fastener			d_{nom} [mm]	8	10		12		15		20	25	

¹⁾ in absence of other national regulations

²⁾ for M16x80

Drop-in Anchor E / ES

Performance
Characteristic values for **shear loads, zinc plated steel**

Annex C3

Table C4: Characteristic values for shear loads, stainless steel A4, HCR

Anchor size		M6x30	M8x30	M8x40	M10x40	M12x50	M12x80	M16x65	M16x80	M20x80
Steel failure without lever arm										
Characteristic resistance (property class 70)	$V_{Rk,s}^0$ [kN]	7,0	10,6	13,4	25,1	41,9	66,5			
Characteristic resistance (property class 80)	$V_{Rk,s}^0$ [kN]	8,7	10,6	13,4	25,1	41,9	66,5			
Partial factor	$\gamma_{Ms}^{1)}$ [-]	1,56								
Factor of ductility	k_7 [-]	1,0								
Steel failure with lever arm										
Characteristic bending resistance (property class 70)	$M_{Rk,s}^0$ [Nm]	11	26	52	92	233	454			
Partial factor	$\gamma_{Ms}^{1)}$ [-]	1,56								
Characteristic bending resistance (property class 80)	$M_{Rk,s}^0$ [Nm]	12	30	60	105	266	519			
Partial factor	$\gamma_{Ms}^{1)}$ [-]	1,33								
Factor of ductility	k_7 [-]	1,0								
Concrete pry-out failure										
Pry-out factor	k_8 [-]	1,0	1,7			2,0				
Concrete edge failure										
Effective length of fastener in shear loading	l_f [mm]	30	30	40	40	50	80	65	80	80
Outside diameter of fastener	d_{nom} [mm]	8	10	12	15	20	25			

¹⁾ in absence of other national regulations

Drop-in Anchor E / ES

Performance
Characteristic values for **shear loads, stainless steel A4, HCR**

Annex C4

Table C5: Displacements under tension loads

Anchor size			M6x30	M8x30	M8x40	M10x30	M10x40	M12x50 M12x80	M16x65 M16x80	M20x80
Steel, zinc plated										
Tension load in uncracked concrete	N	[kN]	3	3	3,6	3,3	4,8	6,4	10	14,8
Displacements	δ_{N0}	[mm]	0,24							
	$\delta_{N\infty}$	[mm]	0,36							
Stainless steel A4 / HCR										
Tension load in uncracked concrete	N	[kN]	4	4	4,3	- ¹⁾	6,1	8,5	12,6	17,2
Displacements	δ_{N0}	[mm]	0,12							
	$\delta_{N\infty}$	[mm]	0,24							

¹⁾ Anchor version is not part of the ETA

Table C6: Displacements under shear loads

Anchor size			M6x30	M8x30	M8x40	M10x30	M10x40	M12x50 M12x80	M16x65 M16x80	M20x80
Steel, zinc plated										
Shear load in uncracked concrete	V	[kN]	2	4	4	5,7	4,0	11,3	18,8	32,2
Displacements	δ_{V0}	[mm]	0,9	0,9	1,0	1,5	0,6	1,2	1,2	1,6
	$\delta_{V\infty}$	[mm]	1,3	1,3	1,5	2,3	0,9	1,9	1,9	2,4
Stainless steel A4 / HCR										
Shear load in uncracked concrete	V	[kN]	3,5	5,2	5,2	- ¹⁾	6,5	11,5	19,2	30,4
Displacements	δ_{V0}	[mm]	1,9	1,1	0,7	- ¹⁾	1,0	1,7	2,4	2,6
	$\delta_{V\infty}$	[mm]	2,8	1,6	1,0	- ¹⁾	1,5	2,6	3,6	3,8

¹⁾ Anchor version is not part of the ETA

Drop-in Anchor E / ES

Performance
Displacements

Annex C5